

## PLEDFHB-V2 Full-Body LED High Bay

### STANDARD



### FEATURES

- Available in 4000k (neutral white) and 5000k (cool white) color temperatures.\*
- Long-life LEDs provide 122,000 hours of operation with at least 70% of initial lumen output (L<sub>70</sub>).\*\*
- Delivers from 12,193 lumens (140 lumens per watt, LPW) to 60,629 lumens (142 LPW).\*
- 0-10vdc dimming drivers are standard. See list of compatible dimmers (page 2).
- Power factor > 0.90.
- Total harmonic distortion < 20%.
- Color rendering index > 80.
- Painted steel housings are standard.
- Chain-mount kits (includes v-hooks and 1/8" thick, 1-meter long chain) are standard.
- Accessories include lenses (clear & diffused), wire-guard kits, surface-mounting kits, pendant-mounting kits, and cable-mounting kits.
- Easy installation in new construction or retrofit.

### WARRANTY & LISTINGS

- cULus listed for damp locations in ambient temperatures from -20°C to 50°C (-4°F to 122°F).
- DLC 5.0 premium approved.
- Flicker-free per IEEE1789-2015 (low risk of adverse effects of flicker at 100% light output level).
- Complies with RoHS (Restriction on Hazardous Substances) requirements.
- Complies with FCC Part 15, class A.
- Complies with IEEE C.62.41-1991, input transient protection (2.5kV).
- 5-year warranty of all electronics and housing.

### ORDERING INFORMATION

Model	Color Temperature		Voltage		Occupancy Sensor		Emergency Driver		
	4K	4000k	MVDIM	120-277V	OS	Passive infrared	EM12	1200	lumens
PLEDFHB90V2	4K	4000k	MVDIM	120-277V	OS	Passive infrared	EM12	1200	lumens
PLEDFHB135V2	5K	5000k	UNC	347-480V	ODS	Microwave	EM16	1600	lumens
PLEDFHB180V2					Blank	No occupancy sensor	EM20	2000	lumens
PLEDFHB215V2							EM24	2400	lumens
PLEDFHB265V2							EC12	1200	lumens
PLEDFHB265V2							EC16	1600	lumens
PLEDFHB320V2							EC20	2000	lumens
PLEDFHB425V2							EC24	2400	lumens
							Blank	No emergency driver	



### MOUNTING OPTIONS

- Chain mounting with V-hooks is standard.
- Optional surface mounting kits provides attachment to flat ceilings.\*
- Optional pendant mounting kits provides pendant attachment to junction boxes.
- Optional cable mounting kits provide suspension at two lengths (i.e., 3 & 5 meters).

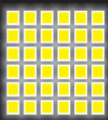

## Compatible Emergency Drivers

Emergency Driver Part Number	EM12 / EC12		EM16 / EC16		EM20 / EC20		EM24 / EC24		Runtime
	Watts	EM Lumens	Watts	EM Lumens	Watts	EM Lumens	Watts	EM Lumens	
PLEDFHB90	7.8	1092	10.7	1498	13.7	1918	17.0	2380	90 MINS.
PLEDFHB135	7.8	1084	10.7	1487	13.7	1904	17.0	2363	
PLEDFHB180	7.8	1092	10.7	1498	13.7	1918	17.0	2380	
PLEDFHB215	7.8	1100	10.7	1509	13.7	1932	17.0	2397	
PLEDFHB265	7.8	1100	10.7	1509	13.7	1932	17.0	2397	
PLEDFHB320	7.8	1076	10.7	1477	13.7	1891	17.0	2346	
PLEDFHB425	7.8	1084	10.7	1487	13.7	1904	17.0	2363	

## Compatible Dimmers

Manufacture	Model Number	Dimming Range	Load Switching Capacity
Lutron	DVSTV	10%-100%	450W
Leviton	IP710-LFZ	10%-100%	1200W
General Protecht	DMD-LED3-102	10%-100%	600W

## Accessories

### Lens

- PLEDFHB-CRLENS-12X23 = Clear lens – 90W, 135W & 180W
- PLEDFHB-CRLENS-17X23 = Clear lens – 215W
- PLEDFHB-CRLENS-12X45 = Clear lens – 265W & 320W
- PLEDFHB-CRLENS-17X45 = Clear lens – 425W
- PLEDFHB-DIFLENS-12X23 = Diffuse lens – 90W, 135W & 180W
- PLEDFHB-DIFLENS-17X23 = Diffuse lens – 215W
- PLEDFHB-DIFLENS-12X45 = Diffuse lens – 265W & 320W
- PLEDFHB-DIFLENS-17X45 = Diffuse lens – 425W

### Wire Guard

- PLEDFHB-WG-12X23 = Wire-guard kit – 90W, 135W & 180W
- PLEDFHB-WG-17X23 = Wire-guard kit – 215W
- PLEDFHB-WG-12X45 = Wire-guard kit – 265W & 320W
- PLEDFHB-WG-17X45 = Wire-guard kit – 425W

### Mounting Options

- PLEDFHB-SMK-12.625WIDE = Surface-mount kit – 90W, 135W, 180W, 265W & 320W
- PLEDFHB-SMK-17.25WIDE = Surface-mount kit – 215W & 425W
- PLEDFHB-PMK = Pendant-mount kit – 90W, 135W, 180W, 265W, 320W, & 425W
- PLEDFHB-PMK8 = Pendant-mount kit – 215W
- PLEDFHB-CMK3 = Cable-mounting kit, 3 meters long
- PLEDFHB-CMK5 = Cable-mounting kit, 5 meters long

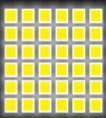

**ELECTRICAL DATA**

Model	Color Temp.	CRI <sup>1</sup>	Luminaire Lumens	Luminaire Watts	Lumens/Watt	Input Voltage <sup>2</sup>	Input Current (A)			Power Factor	THD <sup>3</sup>	L <sub>70</sub> Hours <sup>4</sup>
							120V	240V	277V			
PLEDFHB90-4K-MVDIM-V2	4000k	>80	12,193	87	140	120-277	0.73	0.36	0.31	>90%	<20%	122,000
PLEDFHB90-5K-MVDIM-V2	5000k	>80	12,394	87	142	120-277	0.73	0.36	0.31	>90%	<20%	122,000
PLEDFHB135-4K-MVDIM-V2	4000k	>80	18,401	132	139	120-277	1.10	0.55	0.48	>90%	<20%	122,000
PLEDFHB135-5K-MVDIM-V2	5000k	>80	18,564	132	141	120-277	1.10	0.55	0.48	>90%	<20%	122,000
PLEDFHB180-4K-MVDIM-V2	4000k	>80	24,457	175	140	120-277	1.46	0.73	0.63	>90%	<20%	122,000
PLEDFHB180-5K-MVDIM-V2	5000k	>80	24,603	175	141	120-277	1.46	0.73	0.63	>90%	<20%	122,000
PLEDFHB215-4K-MVDIM-V2	4000k	>80	29,929	213	141	120-277	1.78	0.89	0.77	>90%	<20%	122,000
PLEDFHB215-5K-MVDIM-V2	5000k	>80	30,356	213	143	120-277	1.78	0.89	0.77	>90%	<20%	122,000
PLEDFHB265-4K-MVDIM-V2	4000k	>80	37,590	267	141	120-277	2.23	1.11	0.96	>90%	<20%	122,000
PLEDFHB265-5K-MVDIM-V2	5000k	>80	37,996	267	142	120-277	2.23	1.11	0.96	>90%	<20%	122,000
PLEDFHB320-4K-MVDIM-V2	4000k	>80	44,235	320	138	120-277	2.67	1.33	1.16	>90%	<20%	122,000
PLEDFHB320-5K-MVDIM-V2	5000k	>80	44,460	320	139	120-277	2.67	1.33	1.16	>90%	<20%	122,000
PLEDFHB425-4K-MVDIM-V2	4000k	>80	59,278	428	139	120-277	3.57	1.78	1.55	>90%	<20%	122,000
PLEDFHB425-5K-MVDIM-V2	5000k	>80	60,629	428	142	120-277	3.57	1.78	1.55	>90%	<20%	122,000

<sup>1</sup> Color rendering index.

<sup>2</sup> All 50-60Hz.

<sup>3</sup> Total harmonic distortion.

<sup>4</sup> L<sub>70</sub> refers to the number of hours at which lumen output declines to 70% of the initial level. L<sub>70</sub> hours are IES TM-21-11 calculated hours.

**PHOTOMETRIC DATA**

**PLEDFHB90-5K-MVDIM-V2**  
(12,394 Lumens)

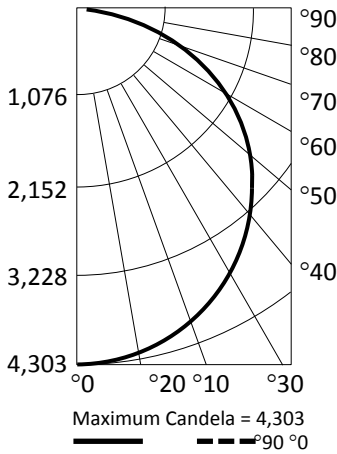

**Candlepower Summary**

°	°0	°90
°0	4,303	4,303
°10	4,274	4,302
°20	4,110	4,154
°30	3,767	3,822
°40	3,305	3,385
°50	2,713	2,841
°60	1,987	2,179
°70	1,176	1,045
°80	385	268
°90	0	0

**Zonal Lumen Summary**

Zone	Lumens	% Fixture
°10 – °0	406	3.3%
°20 – °0	1,582	12.8%
°30 – °0	3,397	27.4%
°40 – °0	5,614	45.3%
°50 – °0	7,947	64.1%
°60 – °0	10,069	81.2%
°70 – °0	11,644	94.0%
°80 – °0	12,313	99.3%
°90 – °0	12,394	100.0%
°180 – °90	0	0.0%
°180 – °0	12,394	100.0%

**Cone of Light**

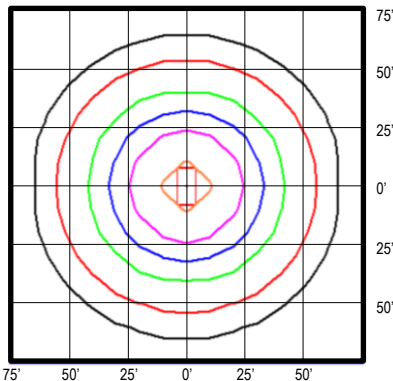
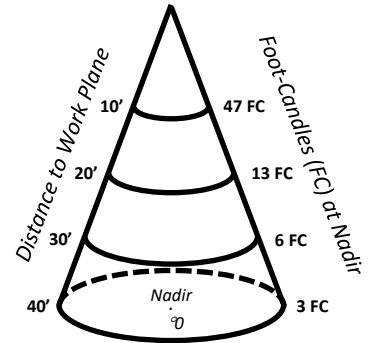

**Foot Candles**

- 5.0
- 2.0
- 1.0
- 0.5
- 0.2
- 0.1

**Notes:**

- Isofootcandle plots depict initial foot-candles at grade.
- Gridlines represent units of mounting height of 25 feet.

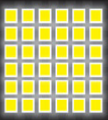

## PHOTOMETRIC DATA

### PLEDFHB135-5K-MVDIM-V2 (18,564 Lumens)

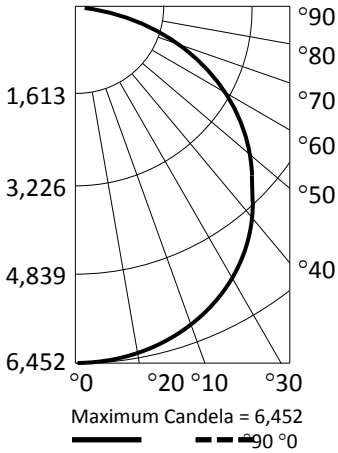

#### Candlepower Summary

	0°	90°
0°	6,452	6,452
10°	6,398	6,438
20°	6,143	6,215
30°	5,642	5,845
40°	4,948	5,133
50°	4,066	4,265
60°	3,003	3,257
70°	1,772	1,305
80°	580	300
90°	0	0

#### Zonal Lumen Summary

Zone	Lumens	% Fixture
0° – 10°	610	3.3%
0° – 20°	2,377	12.8%
0° – 30°	5,110	27.5%
0° – 40°	8,470	45.6%
0° – 50°	11,998	64.6%
0° – 60°	15,214	82.0%
0° – 70°	17,465	94.1%
0° – 80°	18,441	99.3%
0° – 90°	18,564	100.0%
90° – 180°	0	0.0%
0° – 180°	18,564	100.0%

#### Cone of Light

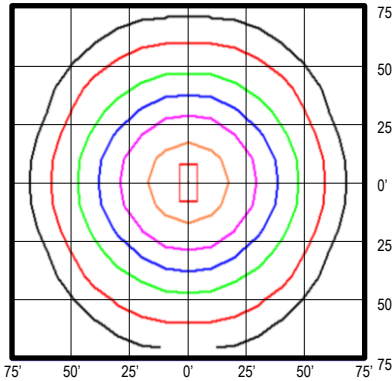
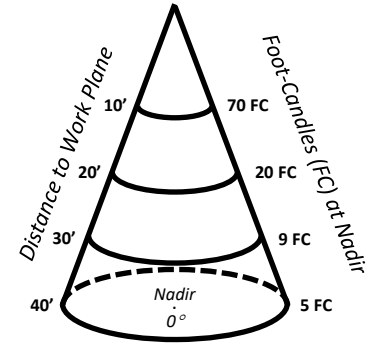

#### Notes:

- Isofootcandle plots depict initial foot-candles at grade.
- Gridlines represent units of mounting height of 25 feet.

### PLEDFHB180-5K-MVDIM-V2 (24,603 Lumens)

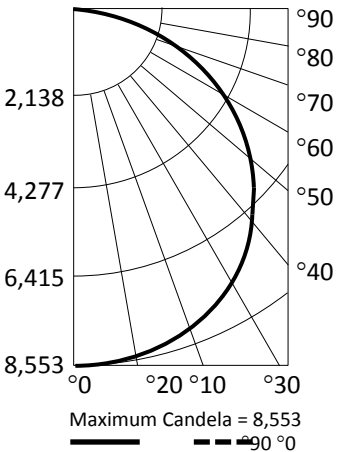

#### Candlepower Summary

	0°	90°
0°	8,553	8,553
10°	8,487	8,480
20°	8,173	8,255
30°	7,487	7,759
40°	6,581	6,870
50°	5,425	5,678
60°	3,993	3,802
70°	2,383	2,084
80°	808	346
90°	0	0

#### Zonal Lumen Summary

Zone	Lumens	% Fixture
10° – 0°	809	3.3%
20° – 0°	3,155	12.8%
30° – 0°	6,787	27.6%
40° – 0°	11,259	45.8%
50° – 0°	15,964	64.9%
60° – 0°	20,185	82.0%
70° – 0°	23,093	93.9%
80° – 0°	24,441	99.3%
90° – 0°	24,603	100.0%
180° – 90°	0	0.0%
180° – 0°	24,603	100.0%

#### Cone of Light

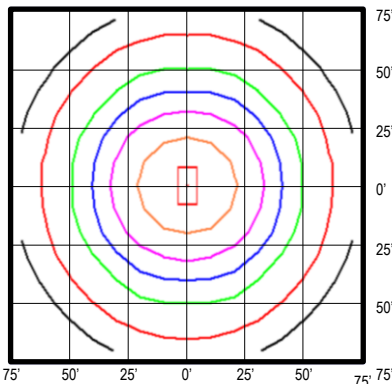
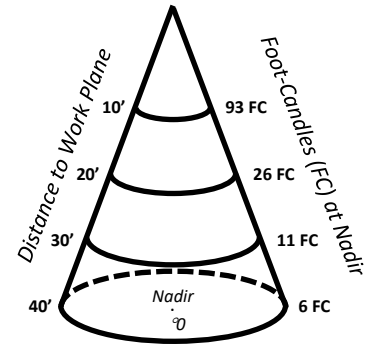

#### Notes:

- Isofootcandle plots depict initial foot-candles at grade.
- Gridlines represent units of mounting height of 25 feet.

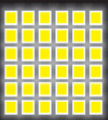

## PHOTOMETRIC DATA

### PLEDFHB215-5K-MVDIM-V2 (30,356 Lumens)

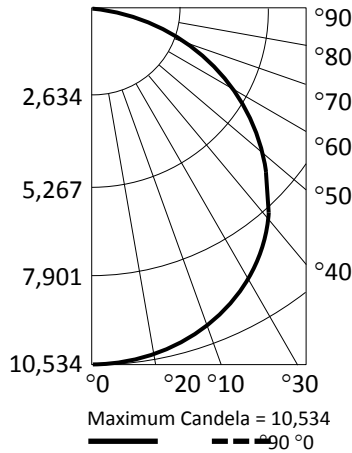

#### Candlepower Summary

	0°	90°
0°	10,534	10,534
10°	10,446	10,436
20°	10,036	10,119
30°	9,191	9,493
40°	8,048	8,416
50°	6,605	7,015
60°	4,857	4,897
70°	2,885	2,838
80°	972	560
90°	0	0

#### Zonal Lumen Summary

Zone	Lumens	% Fixture
0° – 10°	993	3.3%
0° – 20°	3,870	12.7%
0° – 30°	8,310	27.4%
0° – 40°	13,770	45.4%
0° – 50°	19,513	64.3%
0° – 60°	24,683	81.3%
0° – 70°	28,355	93.4%
0° – 80°	30,118	99.2%
0° – 90°	30,356	100.0%
90° – 180°	0	0.0%
0° – 180°	30,356	100.0%

#### Cone of Light

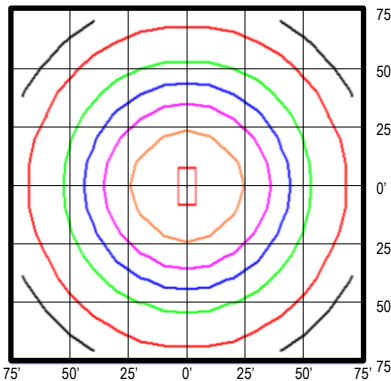
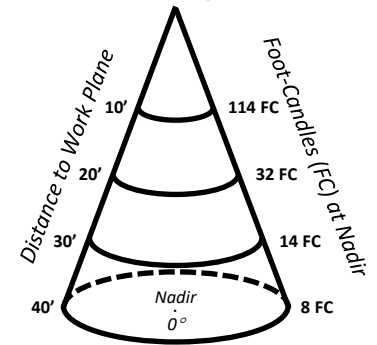

#### Notes:

- Isofootcandle plots depict initial foot-candles at grade.
- Gridlines represent units of mounting height of 25 feet.

### PLEDFHB265-5K-MVDIM-V2 (37,996 Lumens)

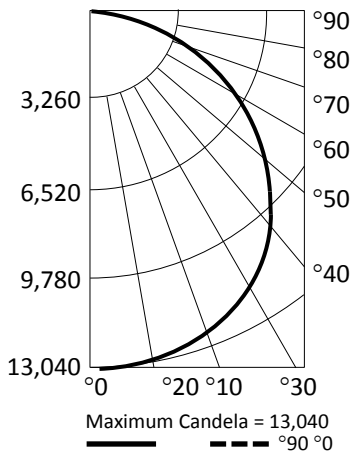

#### Candlepower Summary

	0°	90°
0°	13,040	13,040
10°	12,940	12,943
20°	12,450	12,545
30°	11,488	11,728
40°	10,159	10,193
50°	8,449	8,458
60°	6,305	5,687
70°	3,864	2,705
80°	1,376	592
90°	0	0

#### Zonal Lumen Summary

Zone	Lumens	% Fixture
0° – 10°	1,234	3.2%
0° – 20°	4,813	12.7%
0° – 30°	10,349	27.2%
0° – 40°	17,160	45.2%
0° – 50°	24,351	64.1%
0° – 60°	30,907	81.3%
0° – 70°	35,544	93.5%
0° – 80°	37,692	99.2%
0° – 90°	37,991	100.0%
90° – 180°	5	0.0%
0° – 180°	37,996	100.0%

#### Cone of Light

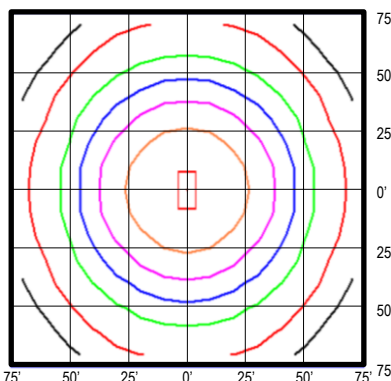
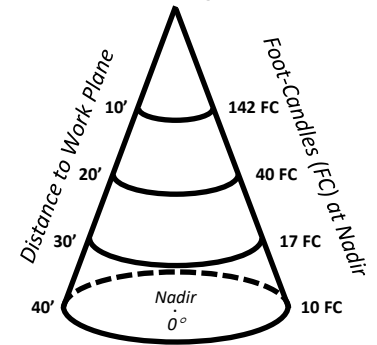

#### Notes:

- Isofootcandle plots depict initial foot-candles at grade.
- Gridlines represent units of mounting height of 25 feet.

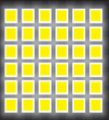

Job Name: \_\_\_\_\_

Type: \_\_\_\_\_

Part #: \_\_\_\_\_

Notes: \_\_\_\_\_

## DIMENSIONS

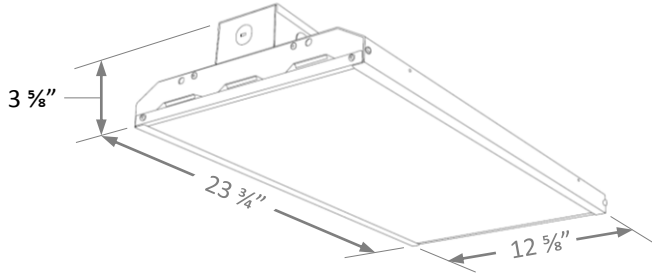

**90 – 180W Models**  
(9.9 – 11.0 lbs.)

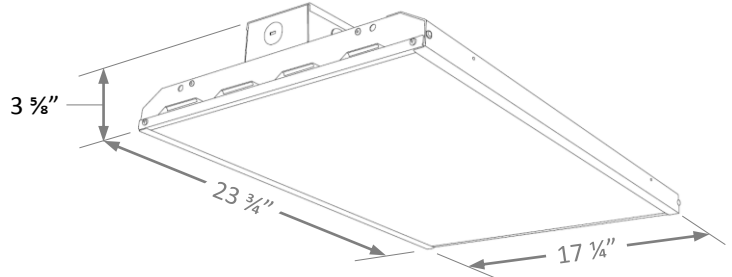

**215W Model**  
(14.0 lbs.)

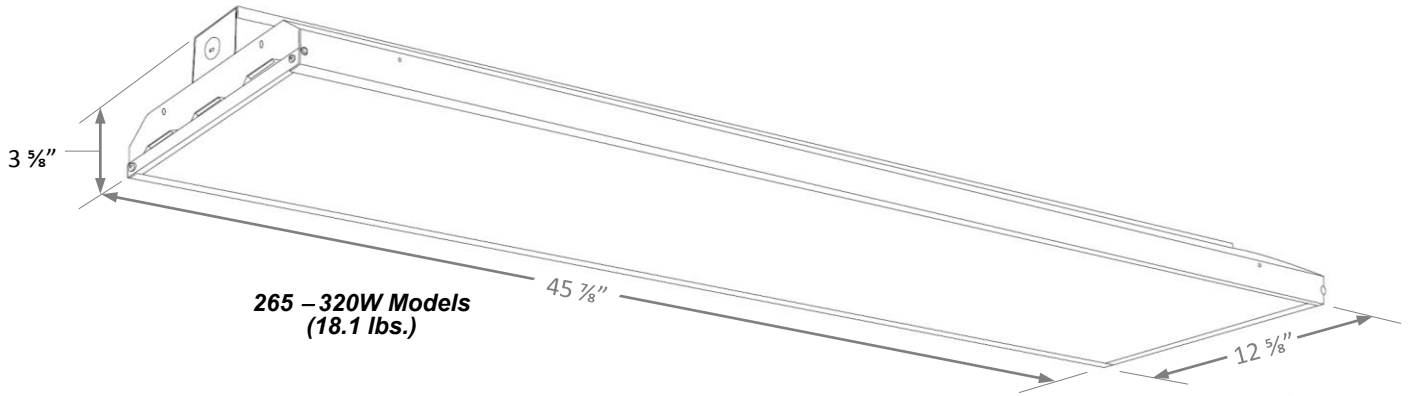

**265 – 320W Models**  
(18.1 lbs.)

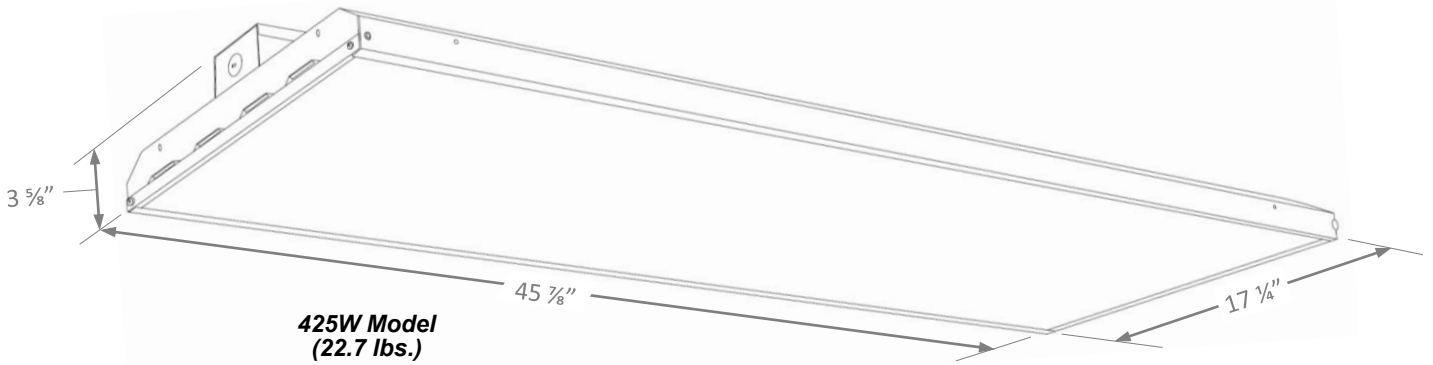

**425W Model**  
(22.7 lbs.)