

Spec Grade  
**PROlite** LED Lighting

A Division of Emergensee® Lighting, Inc.

TYPE: \_\_\_\_\_ DATE: \_\_\_\_\_

JOB NAME: \_\_\_\_\_

CONTRACTOR: \_\_\_\_\_

CATALOG NO: \_\_\_\_\_

NOTES: \_\_\_\_\_

## PCGC Commercial Garage & Canopy Parking Garage & Canopy Light



### FEATURES & SPECIFICATIONS

#### Construction

- Die-cast aluminum optical/lens frame.
- Sleek, low-profile housing (<3.5") with no visible hardware or heat fins.
- Five stage chromate-conversion powder paint manufacturing process provides long life and combats against the elements.
- Hinged quick mount bracket mounts directly to a square or octagonal 4" surface or recessed j-box.
- Standard unit can mounted to a rigid 3/4" pendant/stem (pendant sold separately). Unit comes standard with 5' SO cord.

#### Optical System

- Precisely controlled edge lit technology provides best in class visual comfort as well as high performance.
- Zero uplight.
- Available in 4000K color temperature per ANSI C78.377.
- Minimum CRI of 70.

#### Electrical

- 0-10V dimming (10% - 100%) standard.
- Universal Voltage (120-277 Vac) Input 50/60 Hz.
- L90 Calculated Life: >100k Hours
- Total harmonic distortion: <20%
- Operating temperature: -40°C to +40°C (-40°F to +104°F).
- Power factor: >0.90
- Input power stays constant over life.
- High-efficacy LEDs with integrated circuit board mount directly to the housing to maximize heat dissipation and promote long life.
- Optional 10kV surge protection device meets a minimum Category C Low operation (per ANSI/IEEE C62.41.2).

### ORDERING GUIDE ON NEXT PAGE



#### Controls

- Integral microwave occupancy sensor option available.
- Occupancy sensor is located behind the lens and not visible from below.

#### Warranty

- 5-year limited warranty.

#### Listings

- UL and CUL listed for wet locations
- State of California Title 24 Compliant
- DesignLights Consortium® (DLC) qualified product. Not all versions of this product may be DLC qualified.

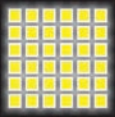

Spec Grade  
**PROlite** LED Lighting

A Division of Emergensee® Lighting, Inc.



TYPE: \_\_\_\_\_ DATE: \_\_\_\_\_

JOB NAME: \_\_\_\_\_

CONTRACTOR: \_\_\_\_\_

CATALOG NO: \_\_\_\_\_



NOTES: \_\_\_\_\_

## ORDERING GUIDE

Model	Output	Distribution	Voltage	Color Temp	Controls	Finish	Options
PCGC		5	UNV	40			SP1
Commercial Garage & Canopy	4L - 4,000 lms 6L - 6,000 lms 8L - 8,000 lms	Type 5	Universal Voltage (120-277V)	4,000K CCT	(Blank) - None  <u>Stand-Alone Controls</u> IMWS - Integral Microwave Sensor (8-20' MH)	BRZ - Bronze GRY - Gray WHT - White	10kV Surge Protector

### Accessory Ordering Information (Accessories are shipped separately and field installed)

#### Pendant Accessories (Field Installed):

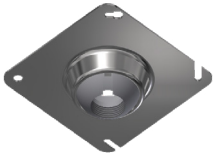
Description	Order Number	Image
3/4"(19mm) Top Decorative Box Cover Aligner	BC600 3	
3/4"(19mm) Top Round Box Cover Aligner	BC585	
3/4"(19mm) Top Square Box Cover Aligner	BC585SQ	

#### Stem Accessories (Field Installed):

Description	Order Number	Image
3/4" x 6" (19mmx152mm) Aluminum Stem	ST 6 3	
3/4" x 12" (19mmx .4m) Aluminum Stem	ST 12 3	
3/4" x 18" (19mmx .5m) Aluminum Stem	ST 18 3	
3/4" x 24" (19mmx .6m) Aluminum Stem	ST 24 3	
3/4" x 36" (19mmx .9m) Aluminum Stem	ST 36 3	
3/4" x 48" (19mmx 1.2m) Aluminum Stem	ST 48 3	

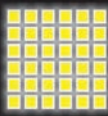

Spec Grade  
**PROlite** LED Lighting

A Division of Emergensee® Lighting, Inc.

TYPE: \_\_\_\_\_ DATE: \_\_\_\_\_

JOB NAME: \_\_\_\_\_

CONTRACTOR: \_\_\_\_\_

CATALOG NO: \_\_\_\_\_

NOTES: \_\_\_\_\_

## PERFORMANCE

DELIVERED LUMENS*						
Lumen Package	Distribution	CRI	4000K CCT			Wattage
			Delivered Lumens	Efficacy	BUG Rating	
4L	5	70	4,672	125	B2-U0-G2	37
6L			6,475	123	B3-U0-G2	53
8L			8,575	119	B3-U0-G2	72

\*LEDs are frequently updated therefore values are nominal.

ELECTRICAL DATA*					
Lumen Level	120V	208V	240V	277V	
4L	0.31	0.18	0.16	0.14	
6L	0.44	0.25	0.22	0.19	
8L	0.60	0.35	0.30	0.26	

\*Electrical data at 25C (77F). Actual wattage may differ by +/-10%.

RECOMMENDED LUMEN MAINTENANCE <sup>1</sup>					
Ambient Temperature	0 hrs. <sup>1</sup>	25K hrs. <sup>1</sup>	50K hrs. <sup>1</sup>	75K hrs. <sup>1</sup>	100K hrs. <sup>1</sup>
0 C -40 C	100%	97%	95%	92%	90%

1. Lumen maintenance values at 25°C are calculated per TM-21 based on LM-80 data and in-situ luminaire testing.

## PHOTOMETRICS

Luminaire photometry has been conducted by a NVLAP accredited testing laboratory in accordance with IESNA LM-79-08. As specified by IESNA LM-79-08 the entire luminaire is tested as the source resulting in a luminaire efficiency of 100%.

## LUMINAIRE DATA

### Type 5 Distribution

Description	4,000 Kelvin, 70 CRI
Delivered Lumens	6,607
Watts	52.7
Efficacy	125
IES Type	Type VS - Short
BUG Rating	B3-U0-G2

### Zonal Lumen Summary

Zone	Lumens	%Luminaire
Low (0-30)°	1070	16%
Medium (30-60)°	3173	48%
High (60-80)°	2070	31%
Very High (80-90)°	295	4%
Uplight (90-180)°	0	0%
Total Flux	6607	100%

### ISO FOOTCANDLE

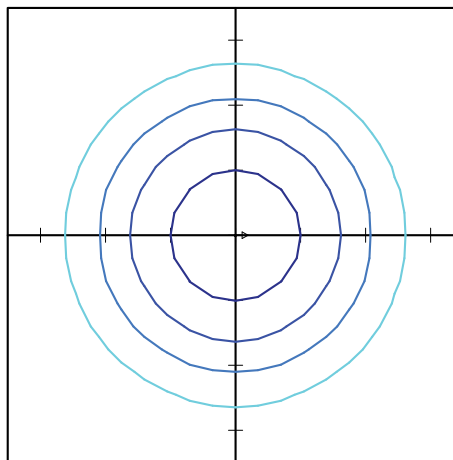

### 10' Mounting Height/10' Grid Spacing

■ 10 FC ■ 5 FC ■ 2 FC ■ 1 FC

### POLAR CURVE

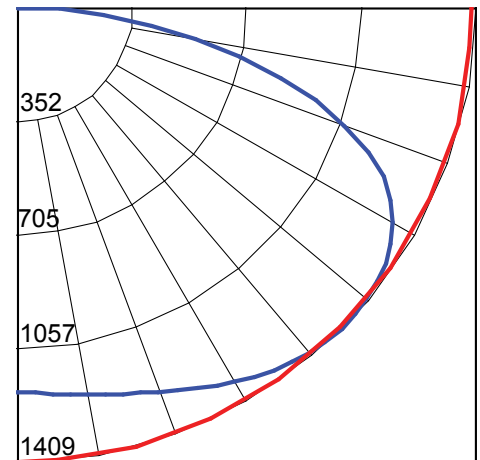

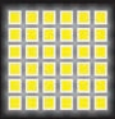

Spec Grade  
**PROlite** LED Lighting

A Division of Emergensee® Lighting, Inc.



TYPE: \_\_\_\_\_ DATE: \_\_\_\_\_  
JOB NAME: \_\_\_\_\_  
CONTRACTOR: \_\_\_\_\_  
CATALOG NO: \_\_\_\_\_  
NOTES: \_\_\_\_\_

### PRODUCT DIMENSIONS

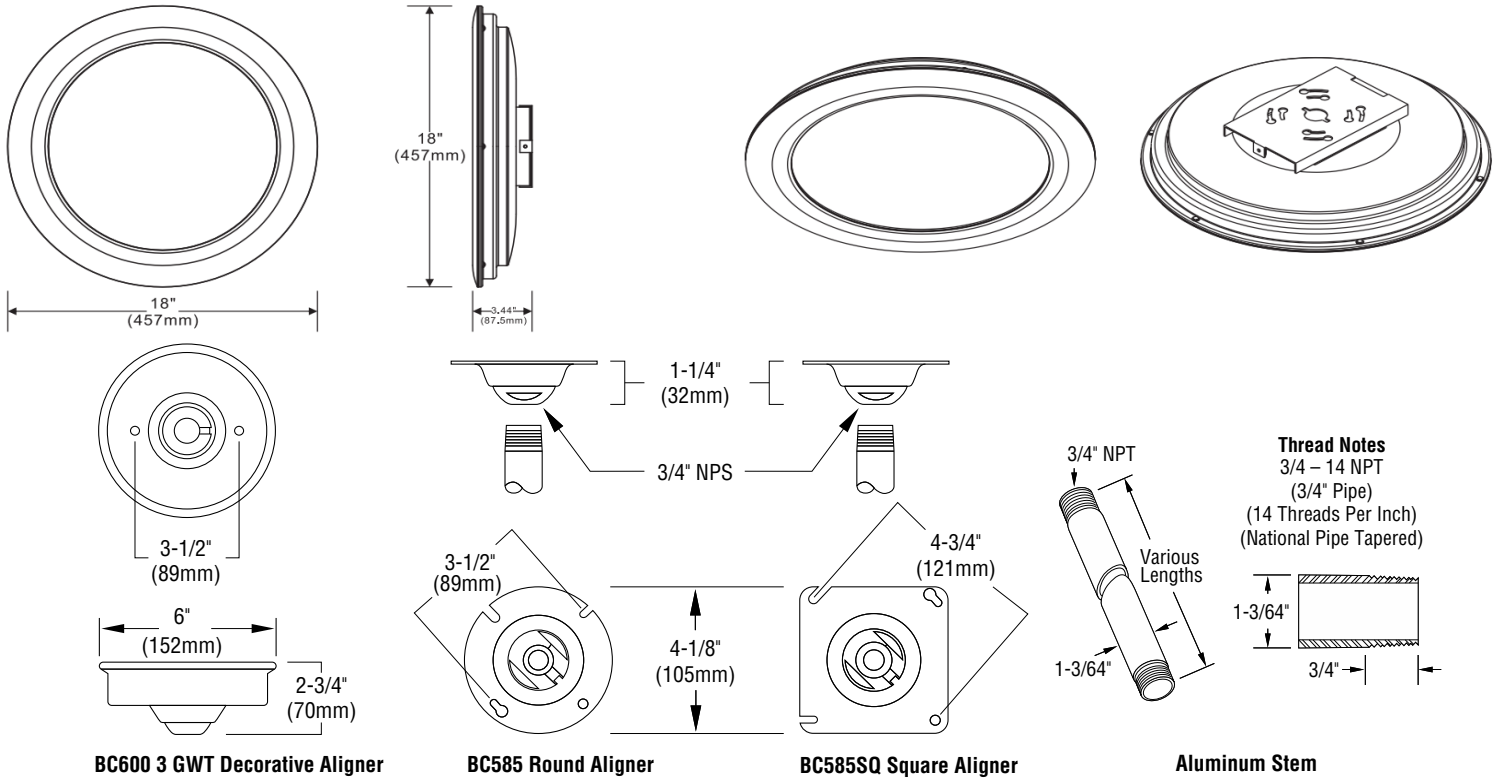

### MOUNTING

#### Direct/Surface Mount

Mounting plate with "quick mount" hanger for one person simple installation to a 4" square or octagonal junction box.



#### Pendant/Stem Mount

3/4" threaded nuts (included) provide mounting to rigid 3/4" pendant/stem (order separately).



### CONTROLS

#### Microwave Sensor (IMWS)

Hidden sensor provides multi-level control based on motion. Microwave sensors provide strong and reliable motion detection ideal for parking garage and canopy applications. Default high setting of 100%, after 15 minutes of no motion detection the sensor will drop the luminaire to the default dim/low setting of 30%. Microwave Sensor is not compatible with external dimming or other control devices.



Mounting height (feet)

